

# Solid wood sauna

## ALASKA

### MINI INFRA+

160 x 110 x 204 cm

INSTRUCTIONS FOR INSTALLATION AND USE  
English

EN



Version 07/18

**sentiotec** DIVISION OF HARVIA GROUP 

ALASKA-MN-IR+  
Ident. no. 1-030-245

## Table of Contents

<b>1. Preparing for installation</b>	<b>3</b>
1.1. Tools required	4
1.2. Maintenance and cleaning	5
1.3. Disposal	5
1.4. ALASKA MINI INFRA+ parts list	6
<b>2. Cabin installation</b>	<b>8</b>
2.1. Base frame installation	8
2.2. Wall element installation	9
2.3. Ceiling installation	16
2.4. Ventilation slit installation	18
2.5. Installing interior fittings	18
2.6. Installing accessories	24
2.7. Installing glass door	26
2.8. Installing roof trim	28
2.9. Installing ceiling cover slat	29
<b>3. Floor plan</b>	<b>30</b>
3.1. Right floor plan	30
3.2. Left floor plan	31
3.3. Changes to the left floor plan installation	32

## 1. Preparing for installation

Read these installation instructions carefully and keep them within reach when using the sauna, so that you can look up product information at any time.



These installation instructions can also be found in the downloads section of our website: [www.sentiotec.com/downloads](http://www.sentiotec.com/downloads).

### Important note:

- Before you begin work, check the parts list to ensure that all the individual parts have been delivered. If you discover any missing parts, notify your dealer within 14 days of receiving the sauna cabin.
- The room that the sauna is installed in must be dry and ensure an appropriate amount of air circulation.
- The floor must be level and even, preferably a stone or tiled floor.
- A minimum room height of 230 cm is required for the cabin installation work.
- A distance of at least 5 cm from the wall must be maintained.
- The inside of the wooden parts used must not be treated with any impregnating material.
- You need an assistant for the installation.
- Wood is a natural product that can swell, shrink or warp, despite good storage. For this reason, some force may be necessary during the installation.
- All screw fittings must be pre-drilled.

EN

### Attention!

**The electrical connection may only be performed by a qualified electrician or similarly trained person.**

### 1.1. Tools required

- Hammer with a wooden head or a mallet
- Cordless screwdriver with bits for cross-head screws and Torx
- Roller tape measure
- Drill bits with a diameter of 3 mm, 10 mm, 20 - 30 mm (for sauna heater power cable)
- Spirit level
- 1.5 mm hexagonal socket wrench
- Utility knife
- Ladder
- Backsaw



This symbol indicates tips and useful information



Pre-drill



Cut to real measurement with backsaw



Check the right angle:

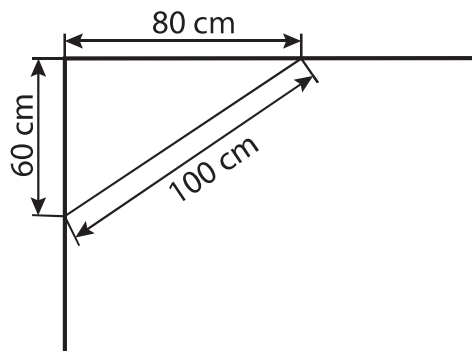

## 1.2. Maintenance and cleaning

- The sauna should be cleaned with a damp cloth. Only use warm water – no cleaning products.
- We recommend heating the cabin once a month if the sauna is not used for a long time.



Pitch pockets are not grounds for return, since they can always appear in spruce wood and the depth at which they lie cannot be detected during the sorting-out process.

If these are just under the surface, heat can cause them to soften and “bleed”.

The leaking pitch can be removed with a rag soaked in acetone. If only droplets of pitch occur, allow these to harden and then carefully scrape them off with a knife.

**EN**

## 1.3. Disposal



- Please dispose of packaging materials in accordance with the applicable disposal regulations.
- Used units contain reusable materials as well as hazardous substances. Therefore, do not dispose of your used unit with household waste, but rather do so in accordance with the locally applicable regulations.

#### 1.4. ALASKA MINI INFRA+ parts list

No. of items	Name	Dimensions
<b>Base frame</b>		
1	Base frame	156 x 9 x 4 cm
1	Base frame	108 x 9 x 4 cm
1	Base frame	102 x 9 x 4 cm
1	Base frame	64 x 9 x 4 cm
<b>Wall elements</b>		
1	A/B wall element with radiator recess	193 x 48 x 4 cm
1	A/B wall element with Multiclip	193 x 48 x 4 cm
1	A/B ventilation element with Multiclip	193 x 48 x 4 cm
4	A/A wall elements with Multiclip	193 x 48 x 4 cm
1	A/A electrical element with Multiclip	193 x 58 x 4 cm
1	Element above door, floor plan (right)	81.5 x 10.1 x 4 cm
1	Element above door, floor plan (left)	81.5 x 10.1 x 4 cm
<b>Ceiling elements</b>		
2	Ceiling elements	146 x 49 x 4 cm
<b>Corner posts</b>		
3	90° corner posts with Multiclip	193 x 6 x 6 cm
1	Corner post with front hinge for glass door with Multiclip	202 x 6 x 7.5 cm
1	Post for glass element, 8 mm groove	202 x 4.5 x 4 cm
<b>Support slats</b>		
2	Roof support slats	140 x 4 x 4 cm
2	Roof support slats	100 x 4 x 4 cm
2	Roof cover slats	144 x 1.2 x 4 cm
2	Roof cover slats	104 x 1.2 x 4 cm
2	Bench support slats	58 x 4 x 4 cm
2	Mounting slats for bench screen	26 x 4 x 4 cm

No. of items	Name	Dimensions
<b>Interior fittings</b>		
1	Bench	147 x 62 x 9 cm
1	Foot step panel	80 x 35 x 9 cm
2	Foot step feet	43 x 33 x 4 cm
2	Foot step struts, 2 x 45° diagonal	49.5 x 8 x 2 cm
2	Backrests	58 x 25.5 x 4 cm
1	Bench screen	147 x 34 x 4 cm
1	Heater protection grille – lime wood	62.5 x 8 x 2 cm
1	Heater protection grille – lime wood	37.5 x 8 x 2 cm
3	Mounting slats for heater protection grille – spruce	7 x 2.5 x 2.5 cm
1	Headrest	43 x 25 x 7 cm
1	Lamp protection grille	38 x 32 x 4 cm
1	Ventilation slit	52 x 14 x 1.5 cm
<b>Glass elements</b>		
1	Glass door	191.5 x 59 x 0.8 cm
1	Glass element	194.5 x 22.4 x 0.8 cm
<b>Roof rim slats</b>		
1	Roof rim slat	160 x 6 x 4 cm
2	Roof rim slats	115 x 6 x 4 cm
<b>Accessories</b>		
1	U aluminium profile	21.1 x 1.2 x 1.5 cm
1	Door handle set wood/stainless steel	
1	2 door hinges 8653-02	
1	Door magnet, sleeve plate	
1	Sauna lamp	
1	Template for Multiclip installation	
1	3 Silicon cables: 5 x 2.5 mm <sup>2</sup>	
1	3 Silicon cables: 3 x 1.5 mm <sup>2</sup>	
1	Infrared radiator ECO-350-R	1-027-785
1	Infracontrol mini	1-035-976
1	Cover panel for Infracontrol mini (2 items)	1-035-503
1	Prestige radiator cover	71 x 21 x 5 cm
1	Installation material set	
1	Installation instructions	

## 2. Cabin installation

The cabin can have a right or left set up, please note the corresponding floor plans on Page 30 and Page 31.

### 2.1. Base frame installation

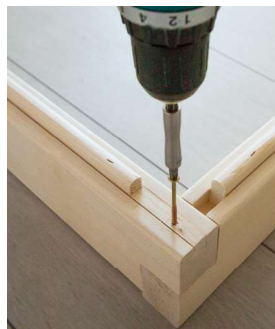
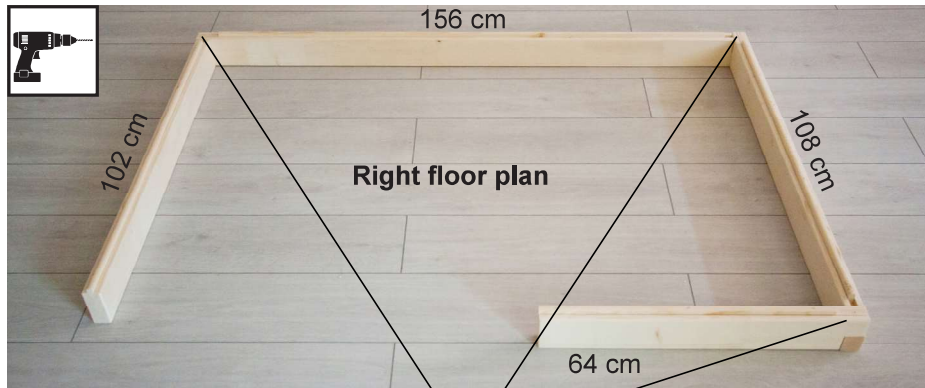

3 mm drill bit, 3 screws 4 x 70 mm





## 2.2. Wall element installation

The corner posts are connected to the wall elements using Multiclips. The other wall elements are connected by tongue and groove and are screwed together.



A always refers to the visible side. This is labelled on the top side of the wall elements.

### Attention!

The installation subsequently described is for the right floor plan. For changes affecting installation for the left floor plan see Page 32.

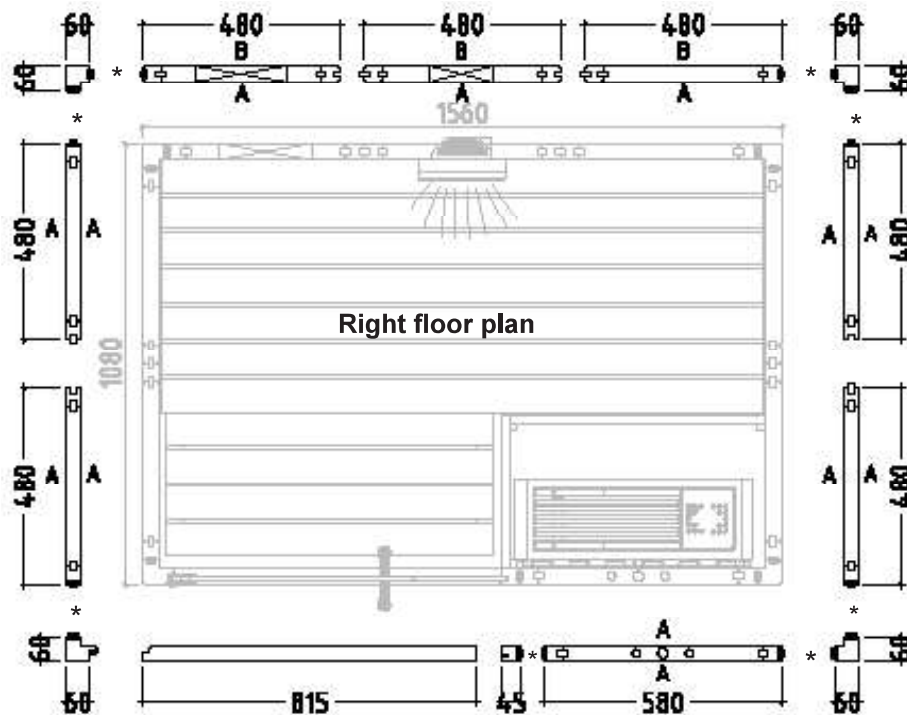

\* Multiclips

**Installing corner posts with wall elements**

 Pre-assemble the wall elements with the corner posts on the floor and then place these posts on the base frame.

Insert the corner post on the wall elements, moving it downwards. When doing this, ensure that the Multiclips are correctly aligned (see below). The corner post must be flush with the wall elements.

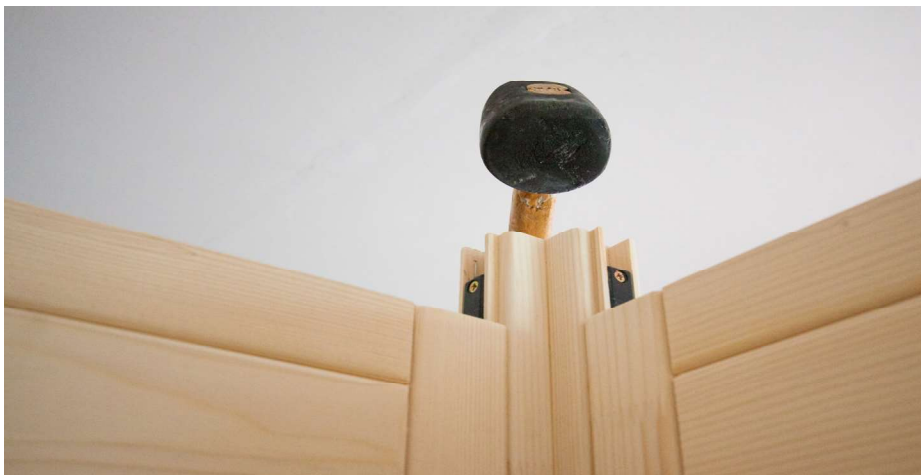
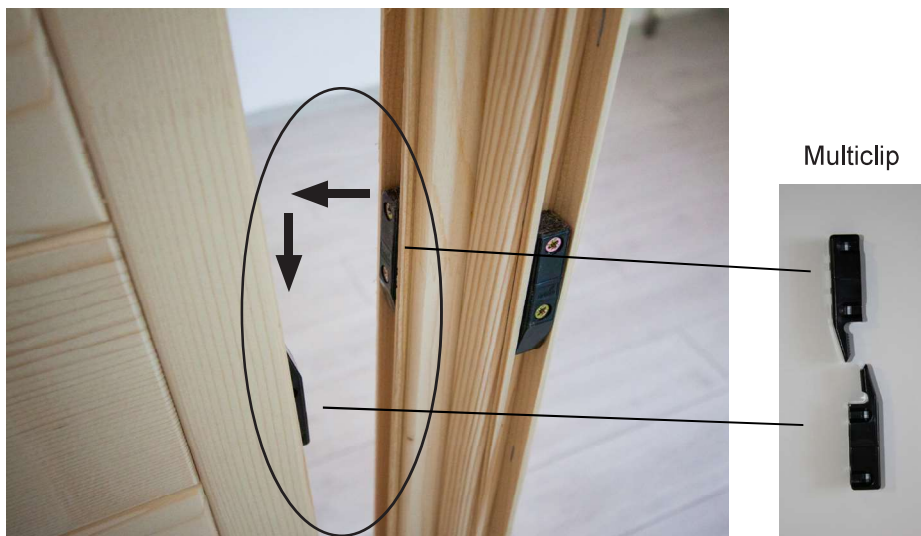

**Installing wall elements**



The electrical element has drill holes for laying cables. For the position, see floor plans on Page 30 and Page 31.



EN



Electrical element

### Screwing wall elements together

 Check the right angle before screwing the wall elements together.  
Observe the tip on page 4.



3 mm drill bit, 4 screws 4 x 70 mm

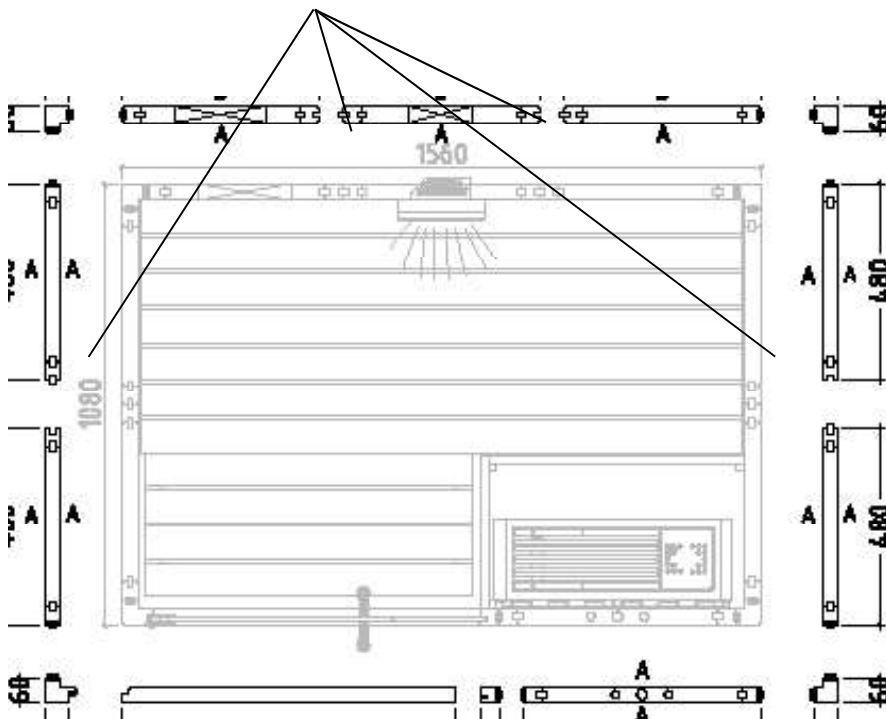

**Corner post and post for glass**

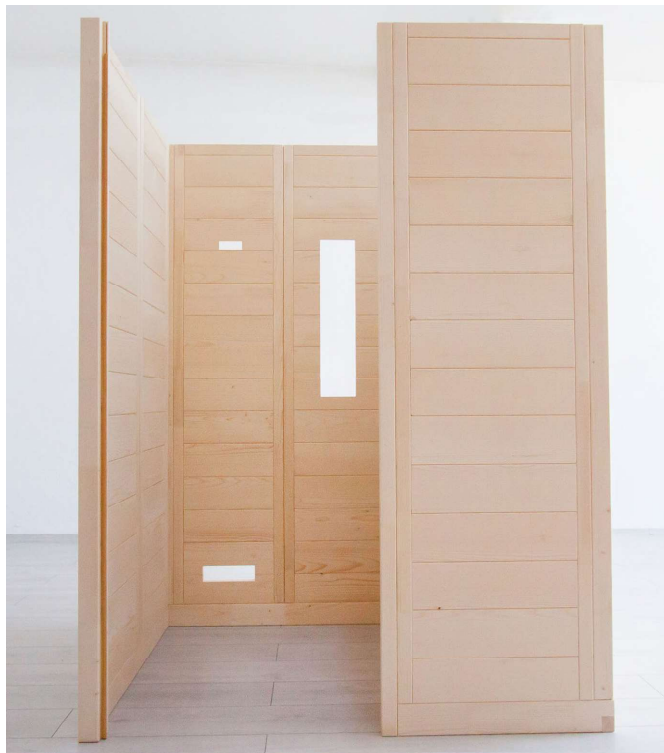

EN

***Glass element***



***Element above the door***

Select the element for the right floor plan



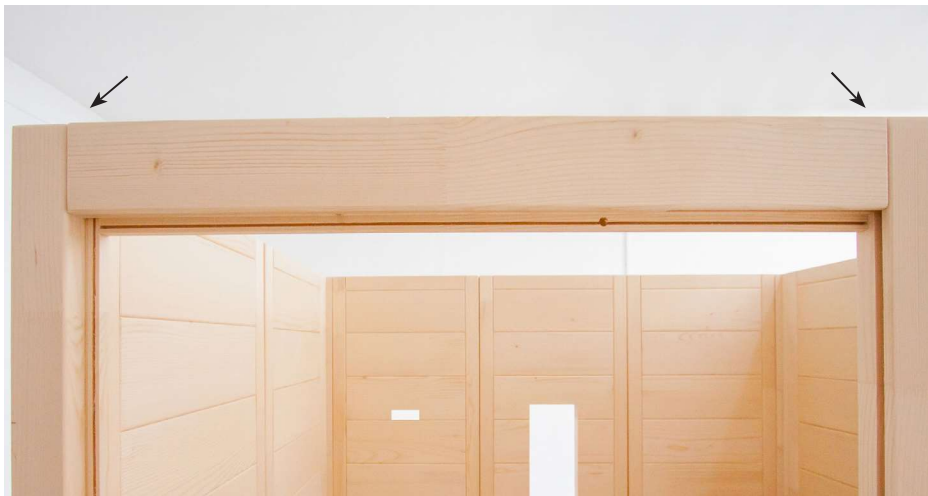

EN

3 mm drill bit, 2 screws 4 x 70 mm

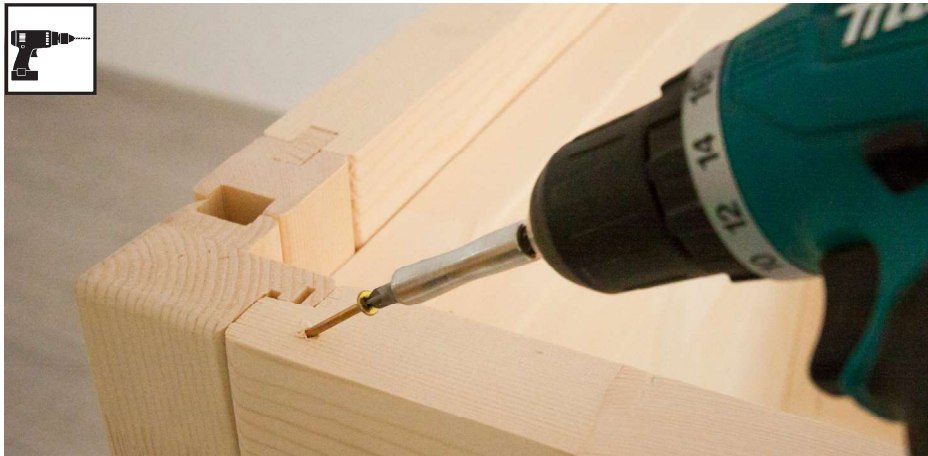

## 2.3. Ceiling installation

### Roof support slats



3 mm drill bit, 12 screws 4 x 70 mm





**Ceiling elements**



3 mm drill bit, 10 screws 4 x 70 mm

## 2.4. Ventilation slit installation



3 mm drill bit, 4 screws 3 x 40 mm

## 2.5. Installing interior fittings

### *Bench support slats*

3 mm drill bit, 3 screws 5 x 70 mm



2 screws 4 x 60 mm

3 mm drill bit, 3 screws 5 x 70 mm



Screws 4 x 60 mm

EN

**Bench screen**

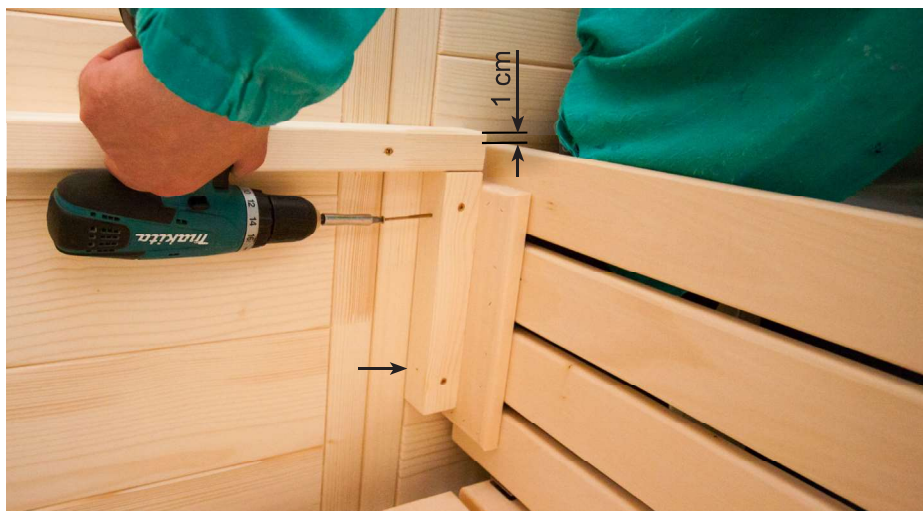

4 screws 4 x 60 mm

**Bench**

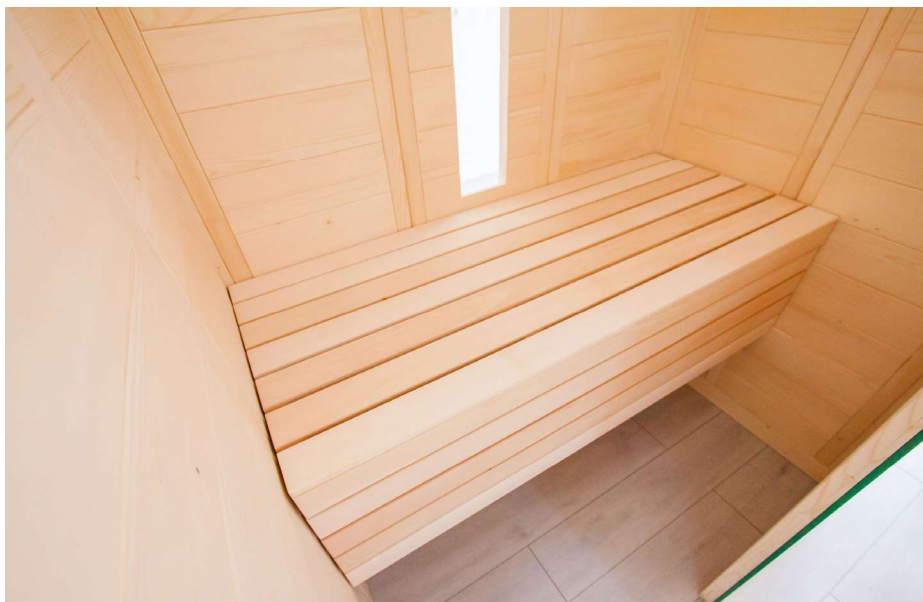

**Foot step**

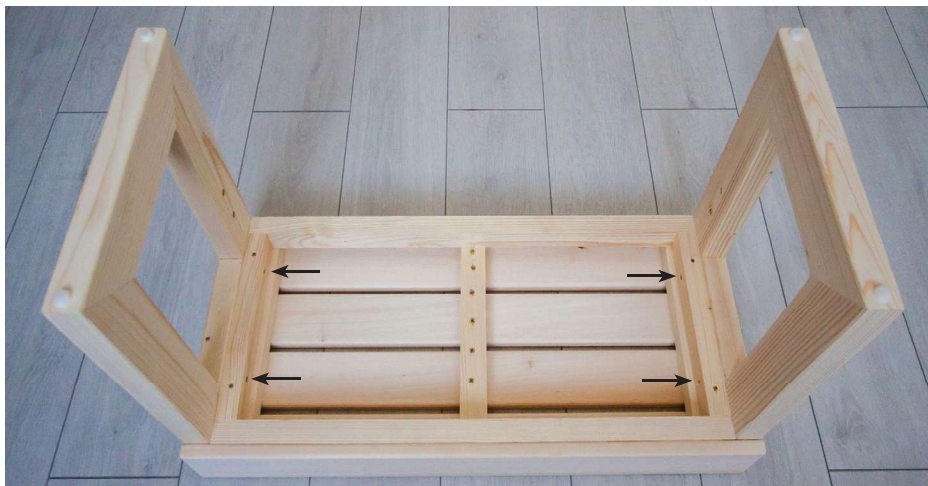

EN

6 screws 4 x 70 mm



4 screws 3.5 x 35 mm



**Infrared radiator and backrests**

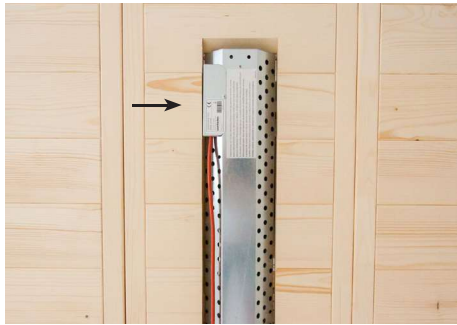

Connection box, top



Label legible



4 screws 3 x 20 mm



4 screws 4 x 60 mm

EN

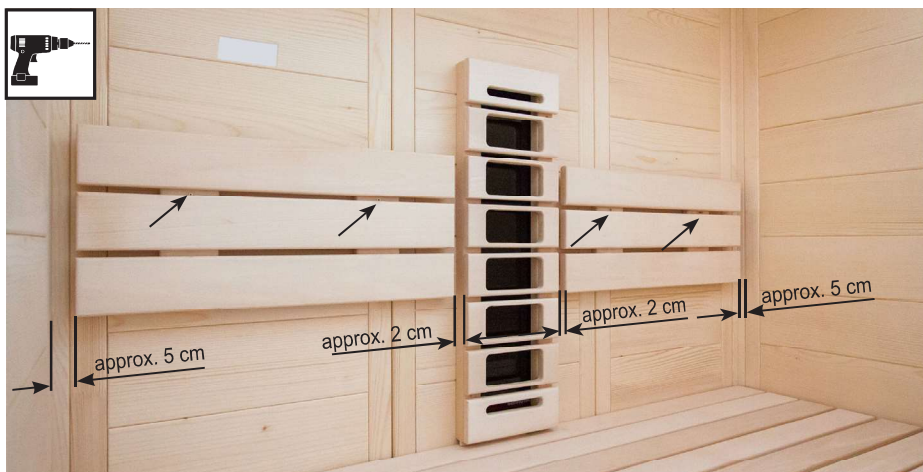

3 mm drill bit, 4 screws 4 x 70 mm

## 2.6. Installing accessories

### Sauna lamp



Insert lamp  
(not included in the scope of delivery)



3 mm drill bit, 2 screws

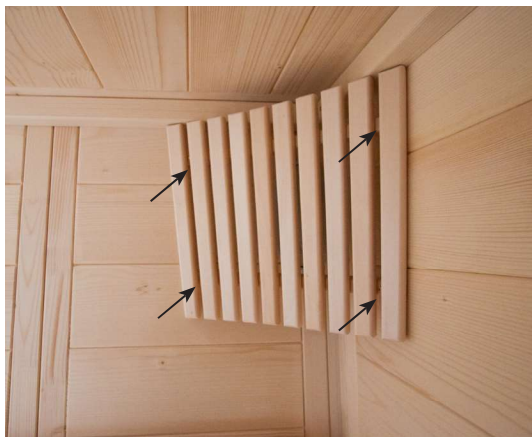

4 screws 3 x 40 mm



**Heater protection grille**

 Before installing the heater protection grille, drill the outlet for the heater cable in the electrical element.

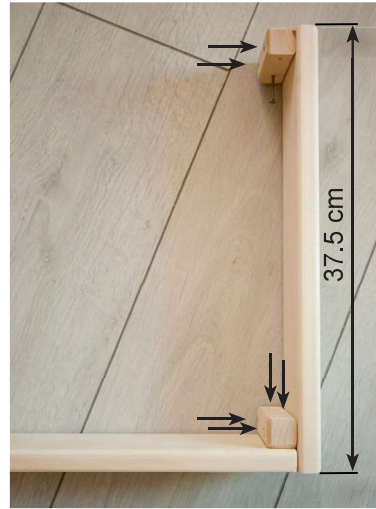

EN

12 screws 3 x 40 mm

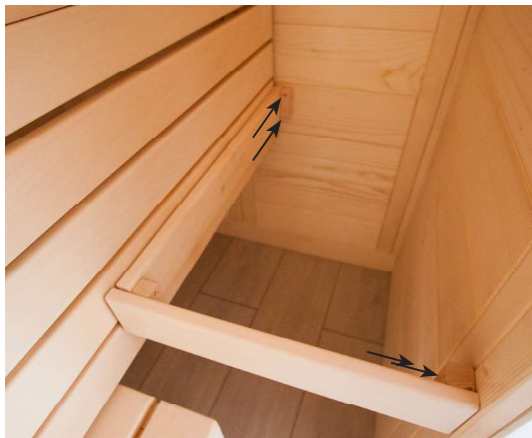

Heater protection grille can be shortened to length

## 2.7. Installing glass door

-  The bottom drill hole of the door handle is 92.4 cm high.  
The alignment of the fittings is achieved by adjusting / rotating both plastic inserts.

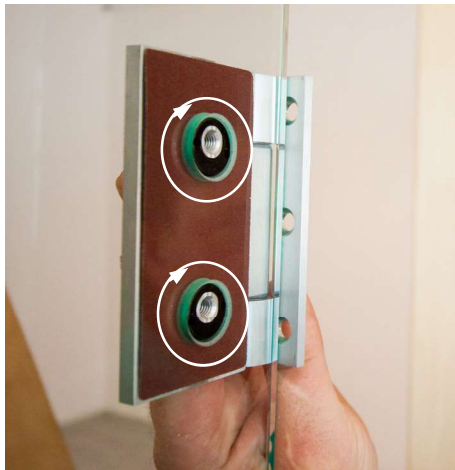

**Door handle and sleeve plate**

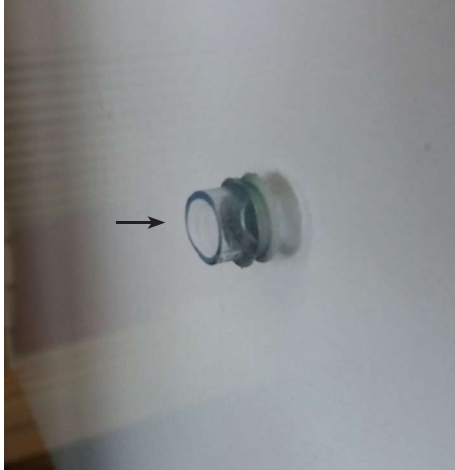

Insert silicone ring in the drill holes

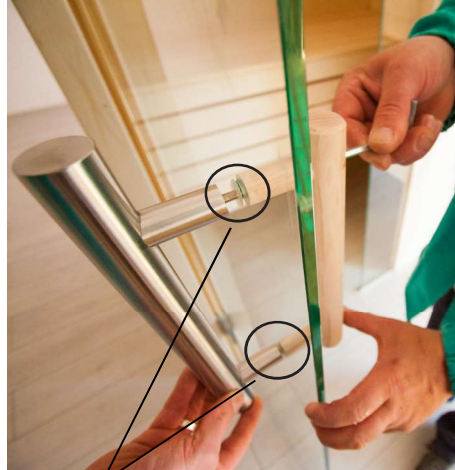

Attach plastic washers on the stainless steel handle

EN



## 2.8. Installing roof trim



Install the roof trim only after you have inserted the cable to the sauna heater and to the sauna control unit. The slat on the electrical element may possibly have to be cut out.

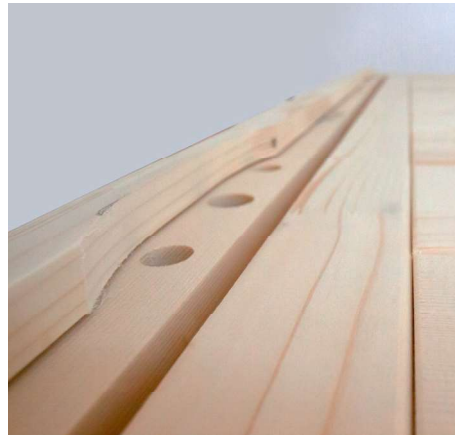

3 mm drill bit, 9 screws 3 x 40 mm

## 2.9. Installing ceiling cover slat

 Install the ceiling cover slat only after you have inserted the cable to the sauna heater and to the sauna control unit. The slat on the electrical element may possibly have to be cut out.



12 screws 3 x 40 mm

EN

### 3. Floor plan

#### 3.1. Right floor plan

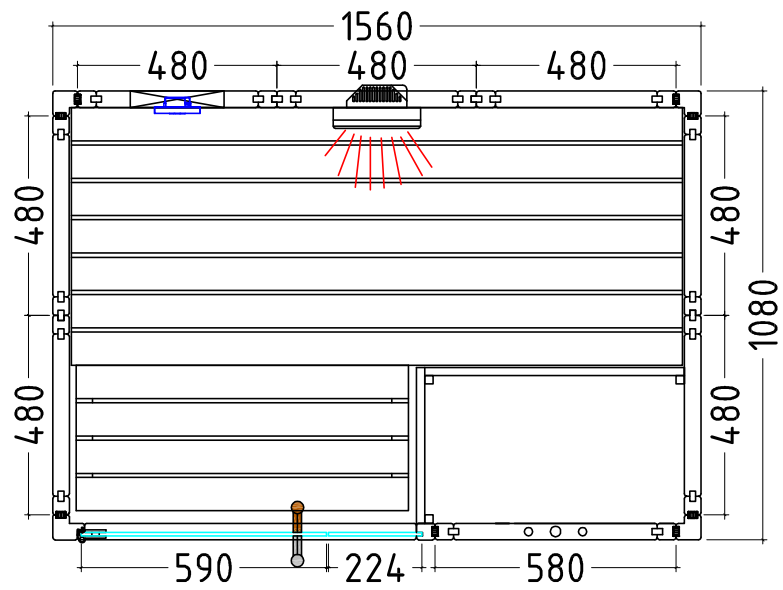

### 3.2. Left floor plan

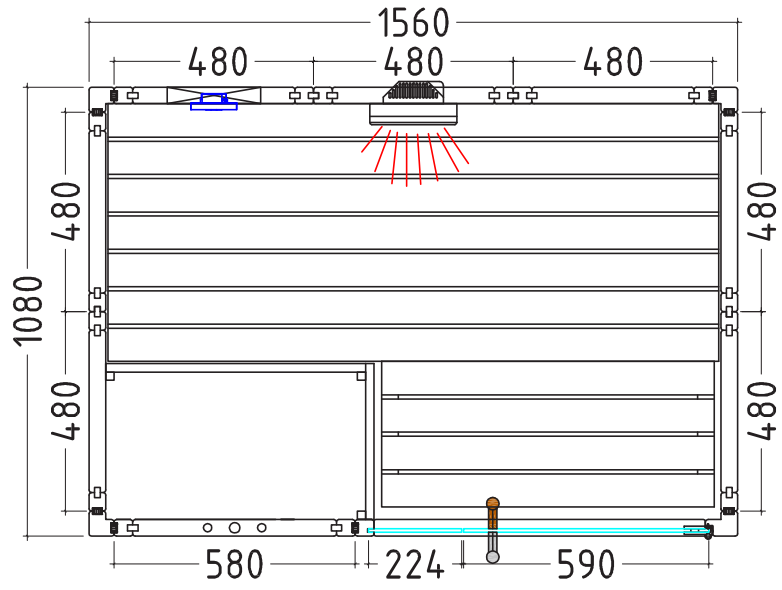

EN

### 3.3. Changes to the left floor plan installation

#### For installing corner posts and posts for the glass (page 14)

Remove the Multiclips from the corner posts and the post for the glass.  
Use the supplied template for the new positioning of the Multiclips.



#### Element above the door (page 15)

Select the element for the left floor plan









sentiotec GmbH | Division of Harvia Group | Oberregauer Straße 48, A-4844 Regau  
Phone +43 (0) 7672/277 20-567 | Fax -801 | info@sentiotec.com | www.sentiotec.com