

1. Tulosta/Print

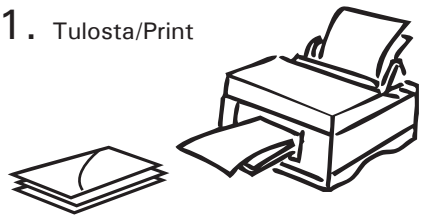

2. Tarkista mittakaava/Check scale



100 mm

3. Leikkaa/Cut

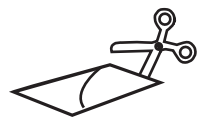

4. Aseta nuolet vastakkain/Align arrowheads

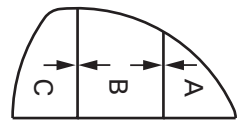

5. Teippaa osat yhteen/Tape parts together

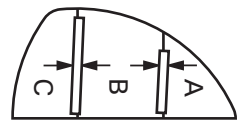

6. Piirrä/Draw

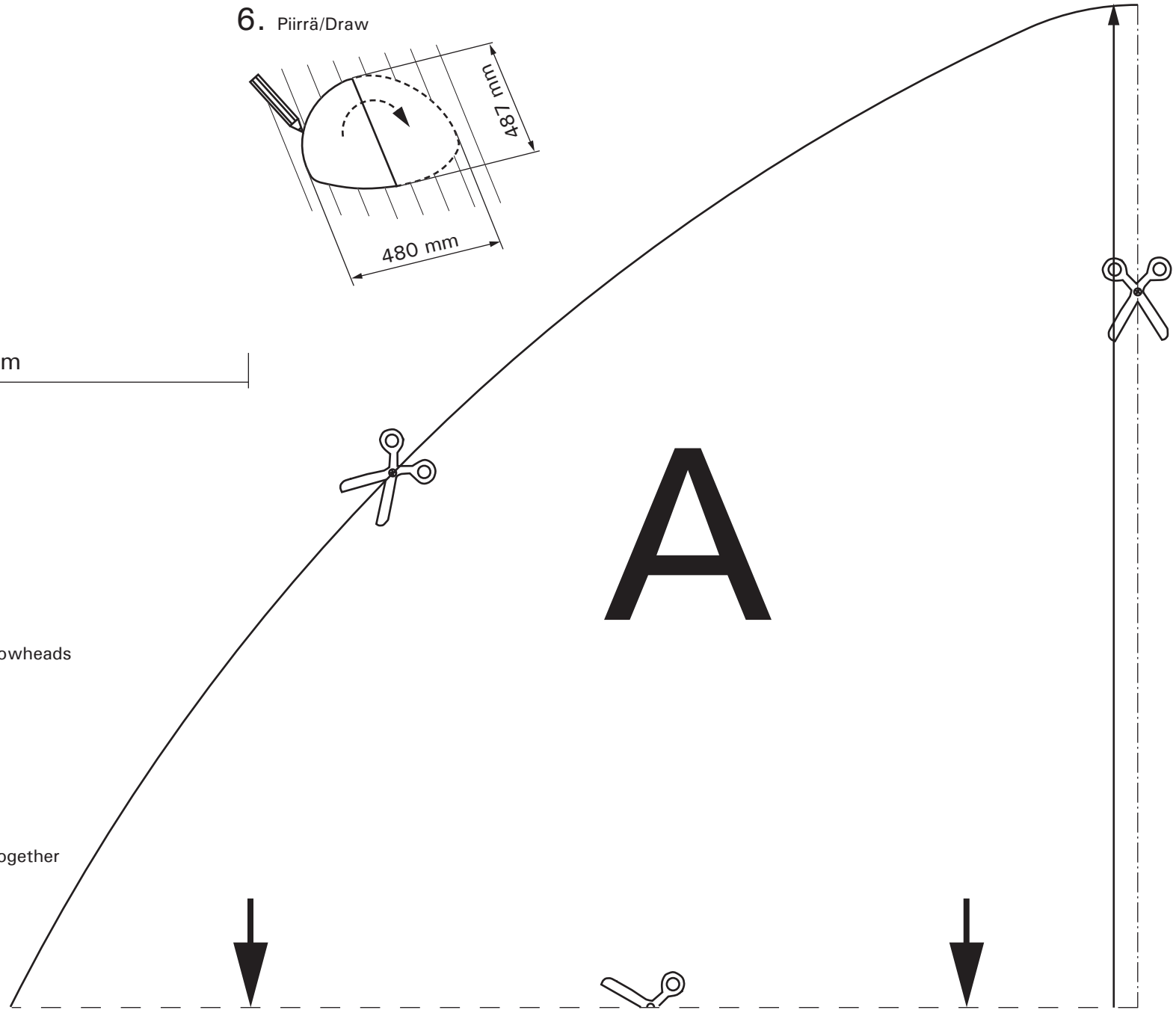
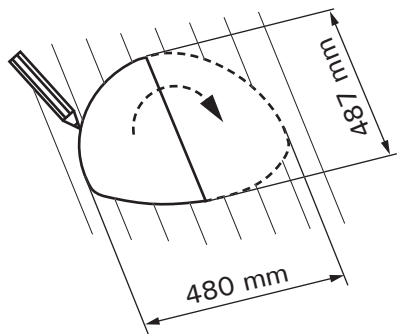

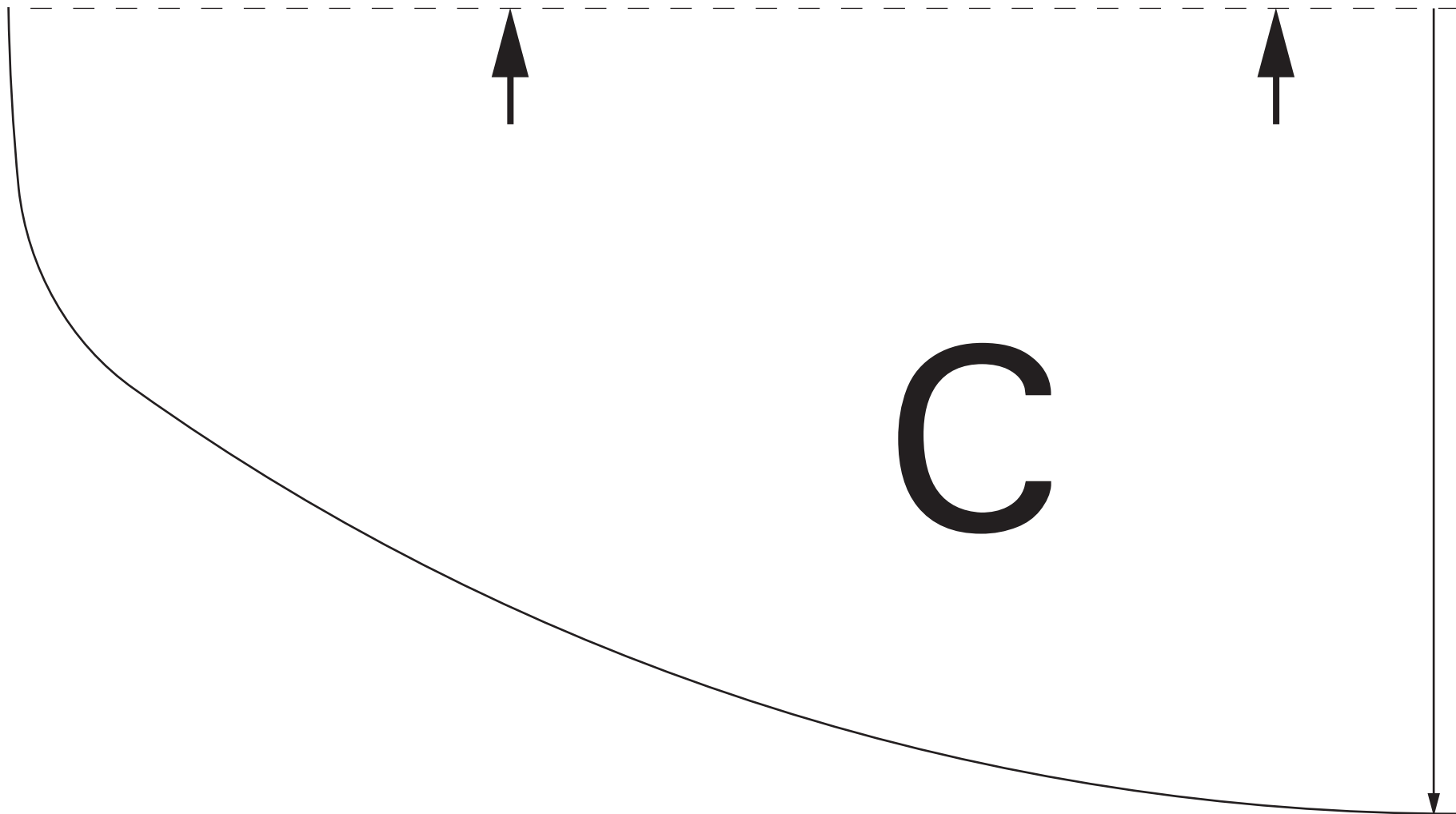

100 mm

HARVIA

Harvia Oy
PL12
40951 Muurame
Finland
www.harvia.fi